

SPECIFICATION

产品规格书

Customer(客户): _____

Part No.(型号): 9.ST2116

Description(描述): 铝基板 五色COB光源

Date(日期): _____

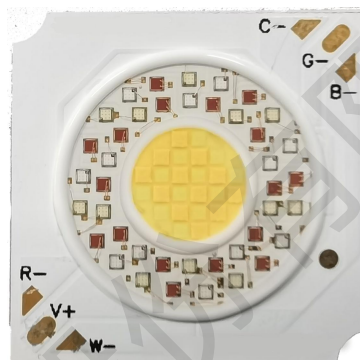

Customer Approved (客户审核)		Approved (确认)	
Xuyu Approved (旭宇审核)		Approved (确认)	Issued (制定)
<input checked="" type="checkbox"/> Sample (样品)		<input type="checkbox"/> Mass Product (量产供货)	

XUYU OPTOELECTRONICS CO.,LTD.

Address: A1 Building, Sunshine Industrial Park, Hezhou, Xixiang, Bao'an District Shenzhen City, Guangdong Province

地址: 广东省深圳市宝安区西乡鹤洲阳光工业区A1栋

Tel 电话: 0755- 81453318-3328/3338

Fax 传真: 0755-81453199

网址: <http://www.xuyuled.com>

目录

Features 特性.....	2
Applications 产品应用.....	2
Package Dimensions 产品外观尺寸.....	3
Product coding rules 产品编码规则.....	4
Optoelectronic Characteristics 光电特性.....	5
Forward Current VS Forward Voltage 伏安特性曲线.....	6
Radiant Flux VS • Forward Current 辐射通量与正向电流.....	6
Spectral Power distribution 光谱能量分布图.....	6
Typical Radiation Angle 典型辐射角度.....	6
Relative Radiant Flux VS Ambient Temperature 相对辐射通量与环境温度.....	6
Packaging Specifications 包装规格.....	7
Label (标签).....	7
CAUTIONS 注意事项.....	8

◆ **Features 特性:**

- *Size(mm): 21*21*1.8 尺寸 (mm) : 21*21*1.8
- *Viewing Angle: 120° 发光角度: 120°
- * High reliability 高可靠性
- * RoHS compliant 通过 RoHS 认证

◆ **Applications 产品应用:**

- *down light, wall lamp, garden light 投光灯, 洗墙灯, 园林灯
- * Landscape lighting, lighting engineering 景观照明, 亮化工程
- * Portable lightings 便携式照明

◆ Package Dimensions 产品外观尺寸

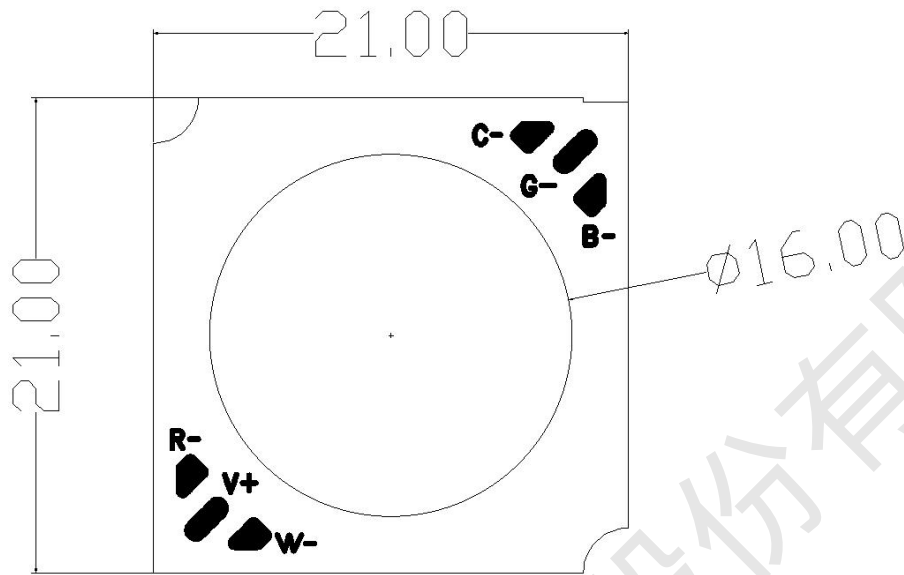

Notes:

1. All dimensions are in mm 所有尺寸单位为毫米。
2. Tolerance is ± 0.2 mm unless otherwise noted. 非特殊标注，公差为 ± 0.2 毫米

◆ Product coding rules 产品编码规则

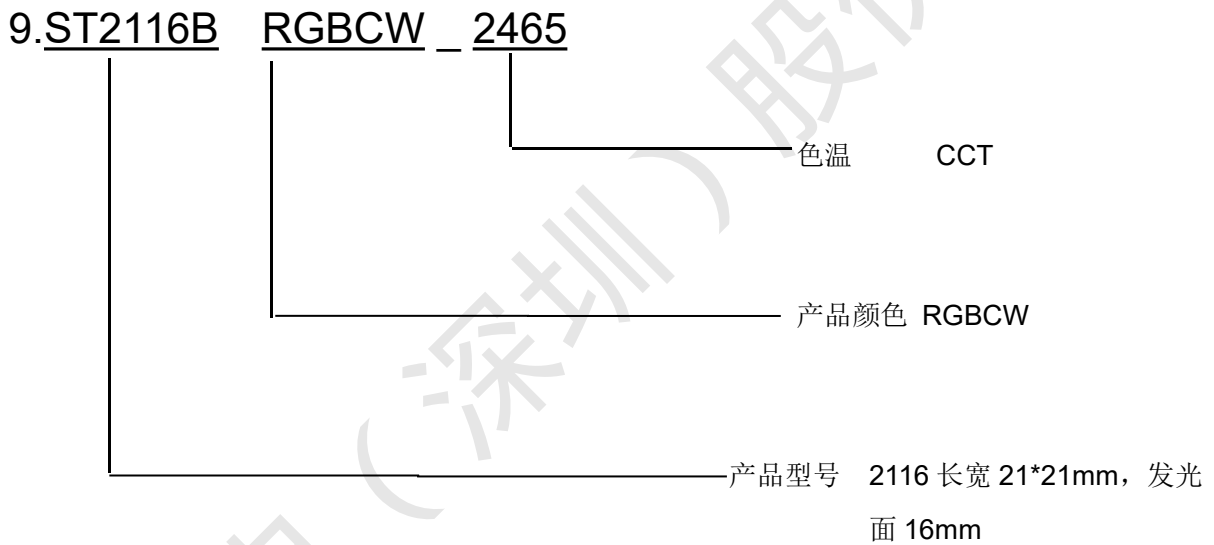
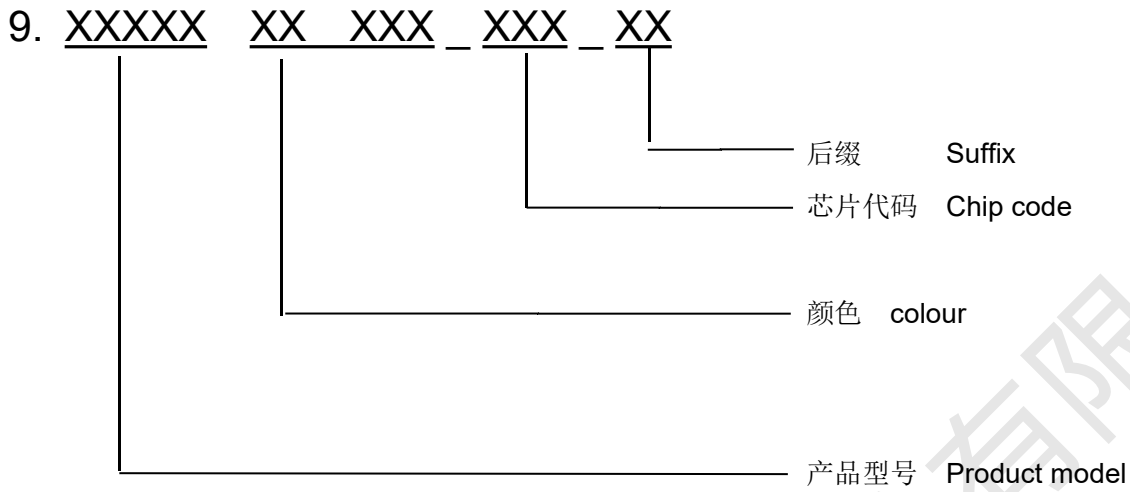

◆ Electro Optical Characteristics (TA=25°C) 光电特性 (RA >90)

Parameter	Symbol	Condition	Color	Min	Avg.	Max	Unit
Forward Voltage (正向电压)	VF	350mA	R	34	36	40	V
		350mA	G	34	36	40	
		350mA	B	34	36	40	
		350mA	C/W	34	36	40	
Luminous Flux (光通量)	Φ(lm)	350mA	R	350		400	lm
		350mA	G	750		850	
		350mA	B	150		200	
		350mA	C/W	900		1000	
Dominant wavelength (主波长)	λ d	350mA	R	620		630	nm
		350mA	G	520		530	
		350mA	B	450		460	
Color temperature (色温)	CCT	350mA	C	5700		6500	k
Color temperature (色温)	CCT	350mA	W	2600		2700	k

◆ Typical Electrical/Optical Characteristic Curves 典型光电特性曲线

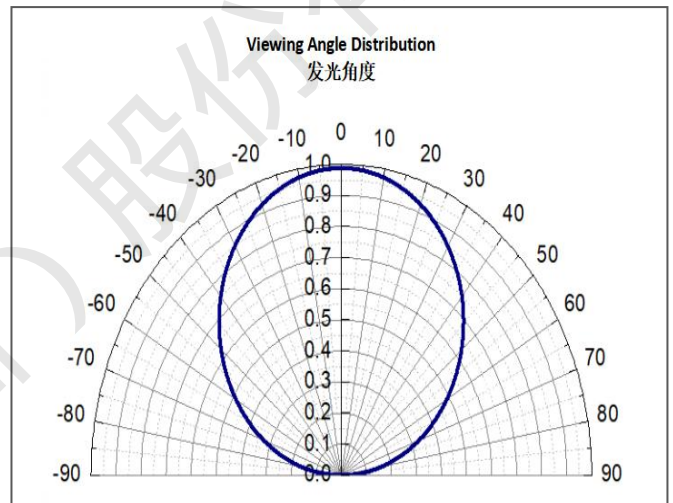
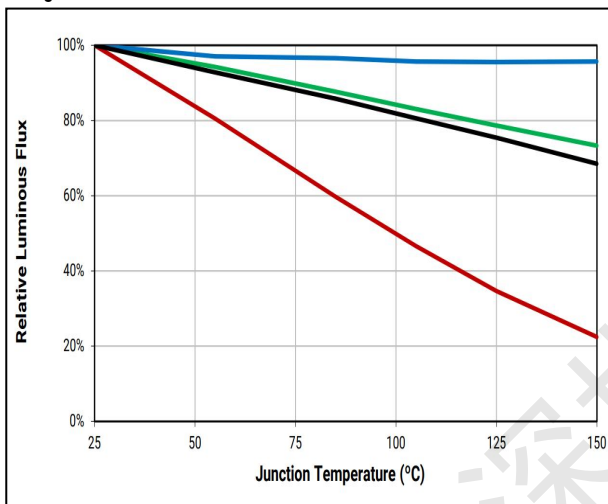
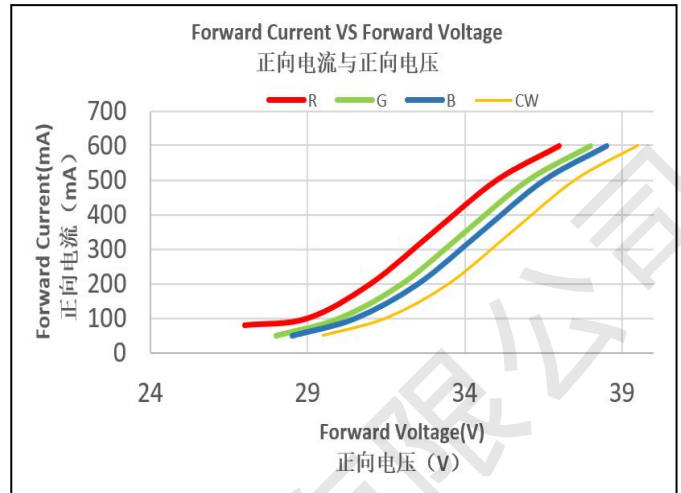
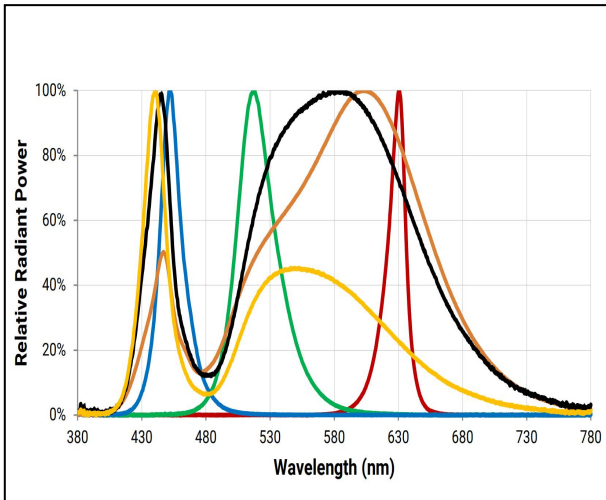

Notes:

1. Related to the temperature test based on the right current. 与温度相关测试基于额定电流。
2. All measurements were made under the standardized environment of XUYU. 所有测试都是基于旭宇光电（深圳）股份有限公司现有的标准测试平台。

◆ Packaging Specifications 包装规格

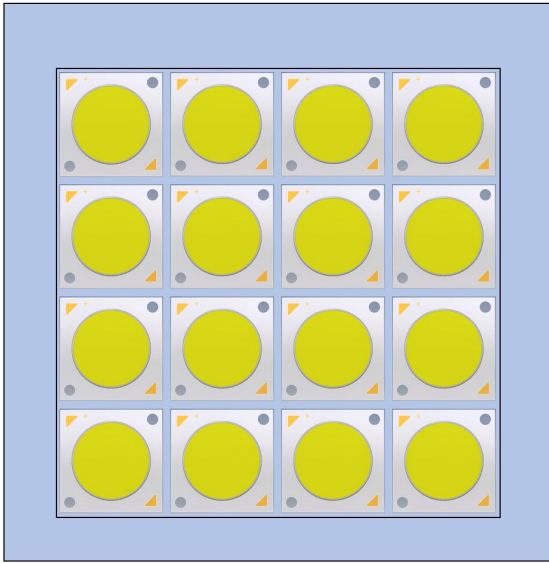

Packaging specifications 包装规格 16PCSx4

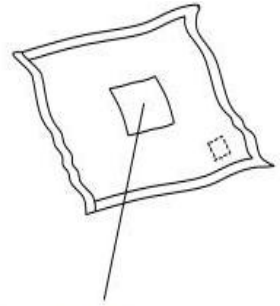
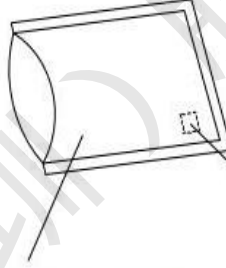
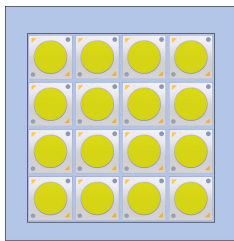

Aluminum moisture-proof bag

Desiccant

Label

◆ Label (标签)

Part NO: 产品型号 Product model

LOT NO: 指令单号 Instruction number

IV/PO: 光通量/功率 Luminous flux /Power

V_F/I_F: 电压/电流 Voltage /Electric current

CCT/XY: 色温/色区 Color temperature / Color Coordinates

Ra/SD/R9: 显色指数/色容差/饱和红色度 Color Rendering index/Color tolerance /R9

Q'ty: 数量 Quantity

Date: 日期 Date

Code: 产品代码 Product code



◆ CARTIONS 注意事项

一、Storage/use 储存/使用:

1. In order to avoid moisture absorption, it is suggested to store the products in a drying cabinet with desiccant. The storage temperature is $5^{\circ}\text{C}\sim 30^{\circ}\text{C}$, and the humidity is $\leq 60\%HR$

1. 为避免吸潮建议将产品贮存在放有干燥剂的干燥柜中, 贮存温度为: $5^{\circ}\text{C}\sim 30^{\circ}\text{C}$, 湿度: $\leq 60\%HR$ 。

2. The encapsulated material of the LEDs is silicone. Therefore the LEDs have a soft surface on the top of package. The pressure to the top surface will be influence to the reliability of the LEDs. Precautions should be taken to avoid the strong pressure on the encapsulated part. So when use the picking up nozzle, the pressure on the silicone resin should be proper.

2. LED 封装为硅胶, 故 LED 胶体表面较软, 用力按压胶体表面会影响 LED 可靠性。应避免使用较大压力按压胶体表面, 在使用吸嘴时, 作用于胶体表面的力应适宜。

3. Handle the component along the side surface by using forceps or appropriate tools; do not directly touch or Handle the silicone lens surface, it may damage the internal circuitry.

3. 采用合适的工具从侧面夹取材料, 不要用手或尖锐金属按压胶体表面, 否则可能导致内部电路损坏。

4. Electrostatic protection. LED is a chip sensitive electronic component. Various measures should be taken to avoid static electricity, such as wearing an electrostatic bracelet or anti-static gloves during use. All devices, equipment and instruments should be well grounded.

4. 静电防护。LED 是晶片敏感电子元器件, 应采取各种措施避免静电, 诸如在使用过程中戴静电手环或防静电手套。所有的装置、设备仪器应良好接地。