

SPECIFICATION

产品规格书

Customer(客户): _____
Part No.(型号): 9.CHP35HW1VB4E_A47
Description(描述): CHP35H 12V 球头
Date(日期): _____

Customer Approved (客户审核)		Approved (确认)	
Xuyu Approved (旭宇审核)		Approved (确认)	Issued (制定)
<input type="checkbox"/> Sample (样品)		<input checked="" type="checkbox"/> Mass Product (量产供货)	

XUYU OPTOELECTRONICS (SHENZHEN)

Address: A1 Building, Sunshine Industrial Park, Hezhou, Xixiang, Bao'an District Shenzhen City, Guangdong Province

地址: 广东省深圳市宝安区西乡鹤洲阳光工业区A1栋

Tel 电话: 0755-81453318-3328/3338

Fax 传真: 0755-81453199

网址: <http://www.xuyuled.com>

目录

Features 特性.....	2
Applications 产品应用.....	2
Package Dimensions 产品外观尺寸.....	3
Product coding rules 产品编码规则.....	4
Optoelectronic Characteristics 光电特性.....	5
Absolute Maximum Ratings 最大额定值.....	5
Forward Current VS Forward Voltage 伏安特性曲线.....	6
Radiant Flux VS • Forward Current 辐射通量与正向电流.....	6
Spectral Power distribution 光谱能量分布图.....	6
Typical Radiation Angle 典型辐射角度.....	6
Relative Radiant Flux VS Ambient Temperature 相对辐射通量与环境温度.....	6
Peak Wavelength VS Ambient temperature 峰值波长与环境温度.....	6
色度区域 Chromaticity Regions	7/8
Packaging Specifications 包装规格.....	9
Label (标签).....	10
SMT Reflow Soldering Instructions SMT 回流焊说明.....	11
CAUTIONS 注意事项.....	12

◆ Features 特性:

- *Size(mm): 3.45*3.45*2.65 尺寸 (mm) : 3.45*3.45*2.65
- *Ceramic and silicone package 陶瓷基板封装
- *Viewing Angle: 120° 发光角度: 120°
- * High reliability 高可靠性
- * RoHS compliant 通过 RoHS 认证
- *Suitable for all SMT assembly and solder process 适用所有 SMT 焊接工艺
- *Pb-free reflow soldering application 无铅回流焊

◆ Applications 产品应用:

- *spot light, ceiling light 天花灯, 球泡灯
- *down light, wall lamp, garden light 投光灯, 洗墙灯, 园林灯
- * Landscape lighting, lighting engineering 景观照明, 亮化工程

◆ Package Dimensions 产品外观尺寸

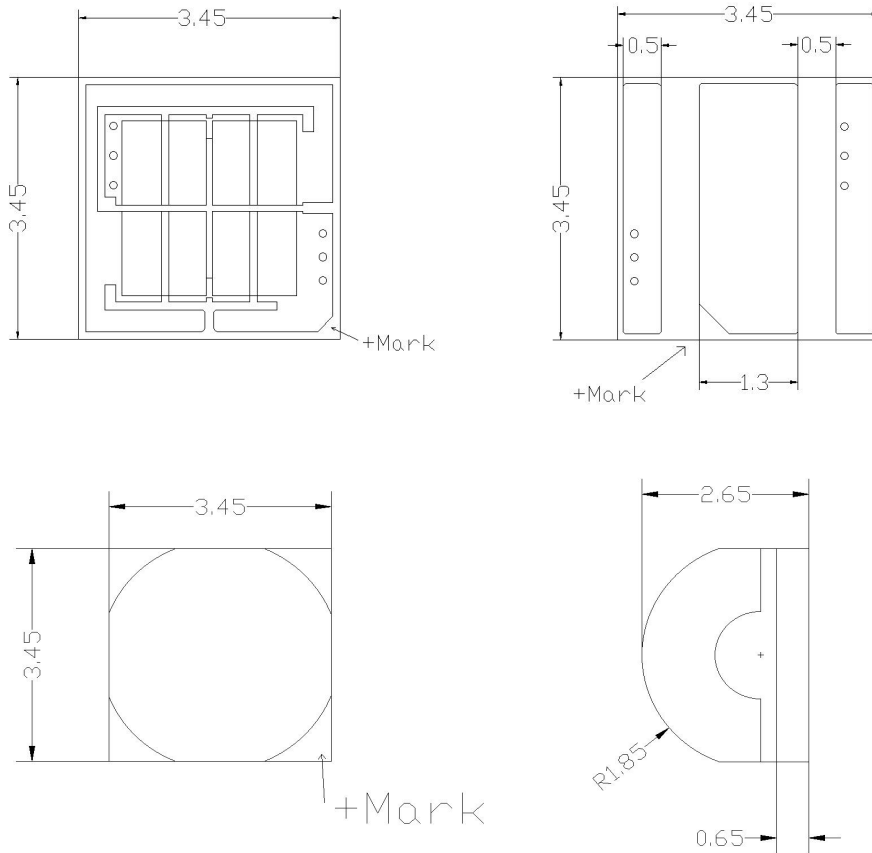

Notes:

1. All dimensions are in mm 所有尺寸单位为毫米。
2. Tolerance is ± 0.1 mm unless otherwise noted. 非特殊标注, 公差为 ± 0.1 毫米

◆ Product coding rules 产品编码规则

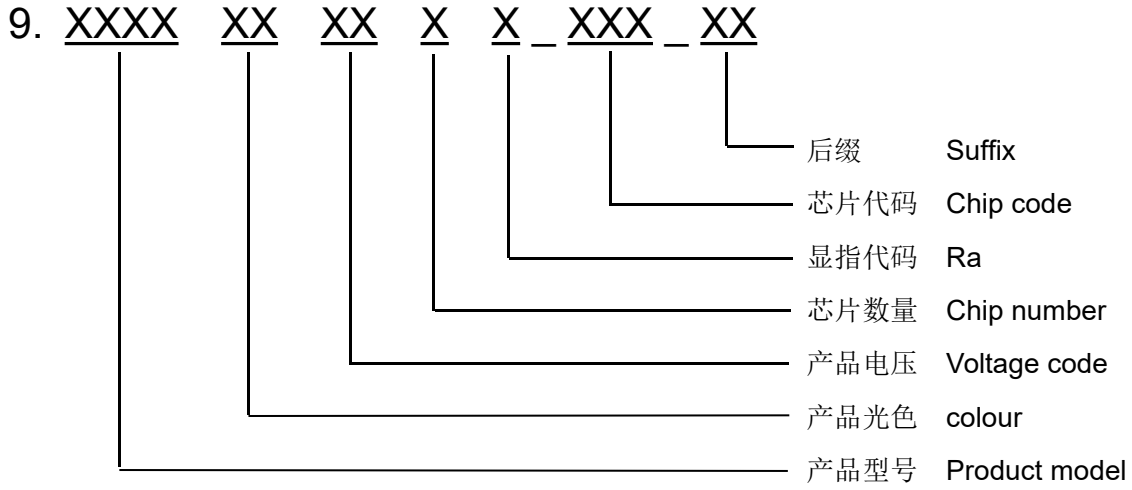

◆ Electro Optical Characteristics (TA=25°C) 光电特性单路

Parameter 参数	Test Condition 测试条件	Symbol 符号	Min 最小值	Typ 典型值	Max 最大值	Unit 单位
Forward Voltage 正向电压	I _F =1000mA	V _F	11	---	13	V
Reverse Current 反向电流	---	I _R	---	---	---	μA
View Angle 发光角度	I _F =1000mA	2θ _{1/2}	---	120	---	deg.
Electrostatic Discharge 抗静电	HBM	ESD	---	---	4000	V
Thermal resistance 有效热阻	I _F =1000mA	R _{J-A}	---	1.65	---	°C/W

◆ Absolute Maximum Ratings (TA=25°C) 最大额定值

Parameter (参数)	Symbol (符号)	Rating (等级)	Unit (单位)
Forward Current 正向电流	I _F	1000	mA
Pulse Forward Current 正向脉冲电流	I _{FP}	1500	mA
Power Dissipation 额定功率	P _O	10	W
Reverse voltage 反向电压	V _R	---	V
Operation temperature 操作温度	T _{opr}	-40 to +85	°C
Storage Temperature Range 储存温度范围	T _{stg}	-40 to +85	°C
Junction Temperature 结温	T _j	125	°C
Soldering Temperature 回流温度	T _{sl}	260°C for 10sec	

NOTE1: Frequency 10KHz, duty ratio ≤10% 频率 10KHz ， 占空比≤10%

NOTE2: The maximum allowable temperature of the pin depends on the current value applied to LED, and the reference chart of "forward current and pin temperature" is required. 引脚的最大允许温度取决于施加在 LED 的电流值，需参考“正向电流与引脚温度”图表。

◆ Mass Production List (I_F=350mA;T_A=25°C) 生产目录

Part NO.型号	Color Rendering index 显指	CCT (K) Min	CCT (K) Typ	CCT (K) Max	Φ (lm) Min	Φ (lm) Max
9.CHP35HW1VB4E_A47	70	---	6500	---	600	650
9.CHP35HW2VB4E_A47	70	---	4000	---	600	650
9.CHP35HW3VB4E_A47	70	---	3000	---	600	650
9.CHP35HW1VB4F_A47	80	---	6500	---	550	600
9.CHP35HW2VB4F_A47	80	---	4000	---	550	600
9.CHP35HW3VB4F_A47	80	---	3000	---	550	600
9.CHP35DW3VB4G_A47	90	---	6500	---	450	520
9.CHP35DW3VB4G_A47	90	---	4000	---	450	520
9.CHP35DW3VB4G_A47	90	---	3000	---	450	520

Note: The test error 测试误差

V_F: ±3%

XY : ±0.005

Φ : ±10%

Ra: ±2

CIE Chromaticity Diagram:(IF=350mA;TA=25°C) CIE 色度图

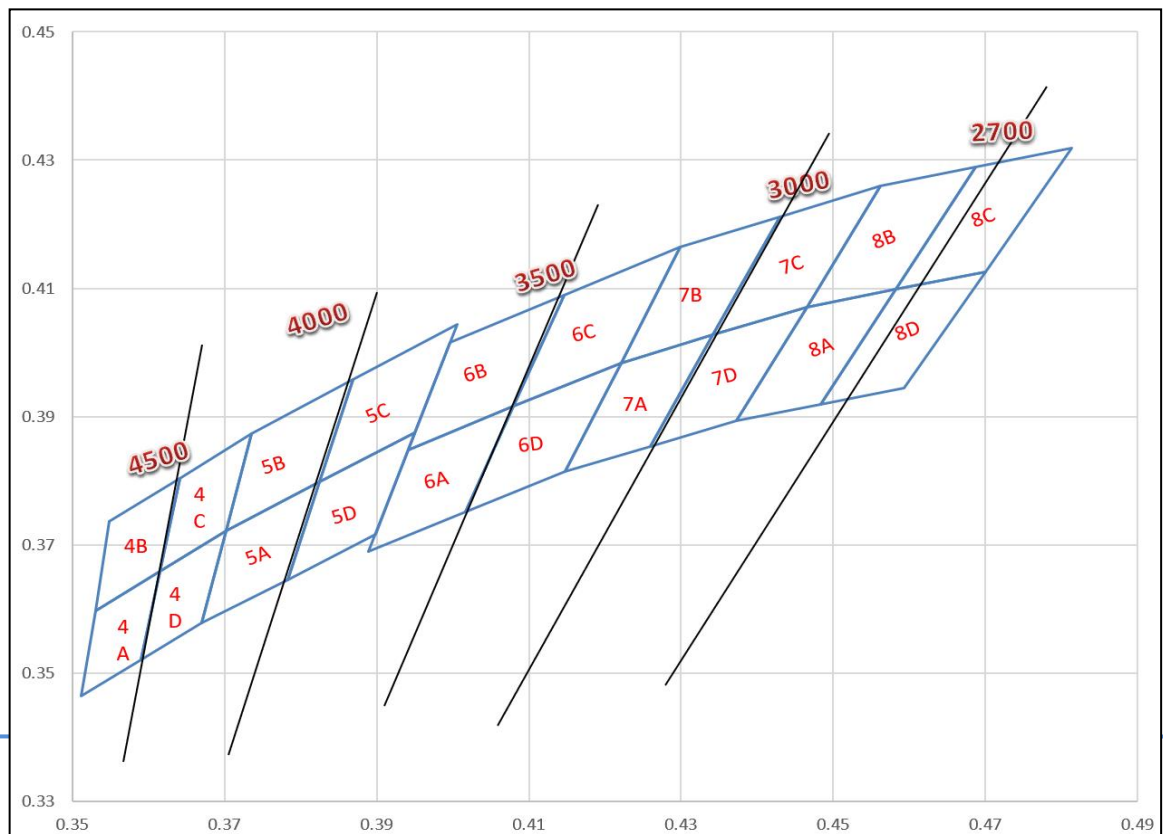
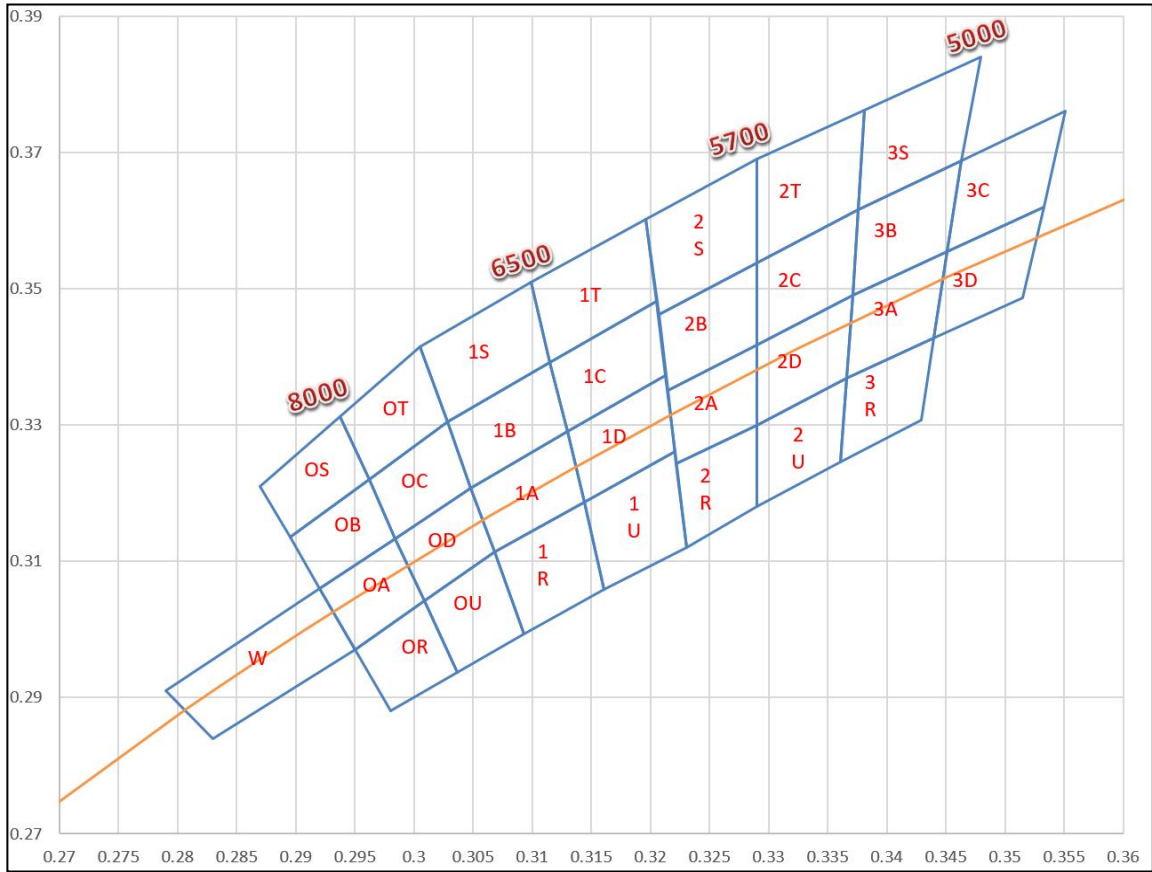

Color Rank :(IF=350mA;TA=25°C) 分 Bin 规格

Region	X	Y	Region	X	Y	Region	X	Y	Region	X	Y
0A	0.295	0.297	0B	0.292	0.306	0C	0.2984	0.3133	0D	0.2984	0.3133
	0.292	0.306		0.2895	0.3135		0.2962	0.322		0.3048	0.3207
	0.2984	0.3133		0.2962	0.322		0.3028	0.3304		0.3068	0.3113
	0.3009	0.3042		0.2984	0.3133		0.3048	0.3207		0.3009	0.3042
0R	0.298	0.288	0S	0.2895	0.3135	0T	0.2962	0.322	0U	0.3037	0.2937
	0.295	0.297		0.287	0.321		0.2937	0.3312		0.3009	0.3042
	0.3009	0.3042		0.2937	0.3312		0.3005	0.3415		0.3068	0.3113
	0.3037	0.2937		0.2962	0.322		0.3028	0.3304		0.3093	0.2993
1A	0.3048	0.3207	1B	0.3028	0.3304	1C	0.3115	0.3391	1D	0.313	0.329
	0.313	0.329		0.3115	0.3391		0.3205	0.3481		0.3213	0.3373
	0.3144	0.3186		0.313	0.329		0.3213	0.3373		0.3221	0.3261
	0.3068	0.3113		0.3048	0.3207		0.313	0.329		0.3144	0.3186
1R	0.3068	0.3113	1S	0.3005	0.3415	1T	0.3099	0.3509	1U	0.3144	0.3186
	0.3144	0.3186		0.3099	0.3509		0.3196	0.3602		0.3221	0.3261
	0.3161	0.3059		0.3115	0.3391		0.3205	0.3481		0.3231	0.312
	0.3093	0.2993		0.3028	0.3304		0.3115	0.3391		0.3161	0.3059
2A	0.3215	0.335	2B	0.3207	0.3462	2C	0.329	0.3538	2D	0.329	0.3417
	0.329	0.3417		0.329	0.3538		0.3376	0.3616		0.3371	0.349
	0.329	0.33		0.329	0.3417		0.3371	0.349		0.3366	0.3369
	0.3222	0.3243		0.3215	0.335		0.329	0.3417		0.329	0.33
2R	0.3222	0.3243	2S	0.3196	0.3602	2T	0.329	0.369	2U	0.329	0.33
	0.329	0.33		0.329	0.369		0.3381	0.3762		0.3366	0.3369
	0.329	0.318		0.329	0.3538		0.3376	0.3616		0.3361	0.3245
	0.3231	0.312		0.3207	0.3462		0.329	0.3538		0.329	0.318
3A	0.3371	0.349	3B	0.3376	0.3616	3C	0.3463	0.3687	3D	0.3451	0.3554
	0.3451	0.3554		0.3463	0.3687		0.3551	0.376		0.3533	0.362
	0.344	0.3427		0.3451	0.3554		0.3533	0.362		0.3515	0.3487
	0.3366	0.3369		0.3371	0.349		0.3451	0.3554		0.344	0.3427
3R	0.3366	0.3369	3S	0.3381	0.3762						
	0.344	0.3428		0.348	0.384						
	0.3429	0.3307		0.3463	0.3687						
	0.3361	0.3245		0.3376	0.3616						

Region	X	Y	Region	X	Y	Region	X	Y	Region	X	Y
4A	0.353	0.3597	4B	0.3548	0.3736	4C	0.3641	0.3804	4D	0.3615	0.3659
	0.3615	0.3659		0.3641	0.3804		0.3736	0.3874		0.3702	0.3722
	0.359	0.3521		0.3615	0.3659		0.3702	0.3722		0.367	0.3578
	0.3512	0.3465		0.353	0.3597		0.3615	0.3659		0.359	0.3521
5A	0.367	0.3578	5B	0.3702	0.3722	5C	0.3825	0.3798	5D	0.3783	0.3646
	0.3702	0.3722		0.3736	0.3874		0.3869	0.3958		0.3825	0.3798
	0.3825	0.3798		0.3869	0.3958		0.4006	0.4044		0.395	0.3875
	0.3783	0.3646		0.3825	0.3798		0.395	0.3875		0.3898	3716
6A	0.3889	0.369	6B	0.3941	0.3848	6C	0.408	0.3916	6D	0.4017	0.3751
	0.3941	0.3848		0.3996	0.4015		0.4146	0.4089		0.408	0.3916
	0.408	0.3916		0.4146	0.4089		0.4299	0.4165		0.4221	0.3984
	0.4017	0.3751		0.408	0.3916		0.4221	0.3984		0.4147	0.3814
7A	0.4147	0.3814	7B	0.4221	0.3984	7C	0.4342	0.4028	7D	0.4259	0.3853
	0.4221	0.3984		0.4299	0.4165		0.443	0.4212		0.4342	0.4028
	0.4342	0.4028		0.443	0.4212		0.4562	0.426		0.4465	0.4071
	0.4259	0.3853		0.4342	0.4028		0.4465	4071		0.4373	0.3893
8A	0.4373	0.3893	8B	0.4465	0.4071	8C	0.4582	0.4099	8D	0.4483	0.3919
	0.4465	0.4071		0.4562	0.426		0.4687	0.4289		0.4582	0.4099
	0.4582	0.4099		0.4687	0.4289		0.4813	0.4319		0.47	0.4126
	0.4483	0.3919		0.4582	0.4099		0.47	0.4126		0.4593	0.3944

◆ Typical Electrical/Optical Characteristic Curves 典型光电特性曲线

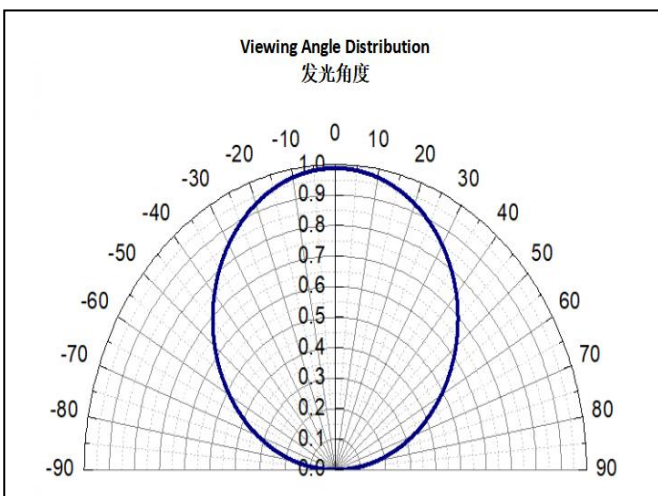
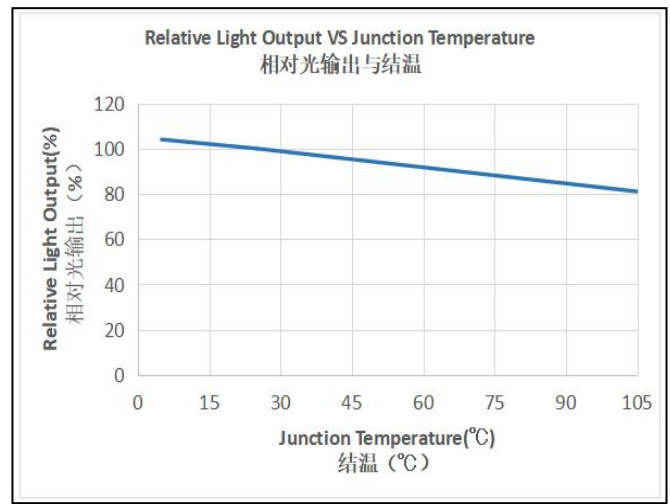
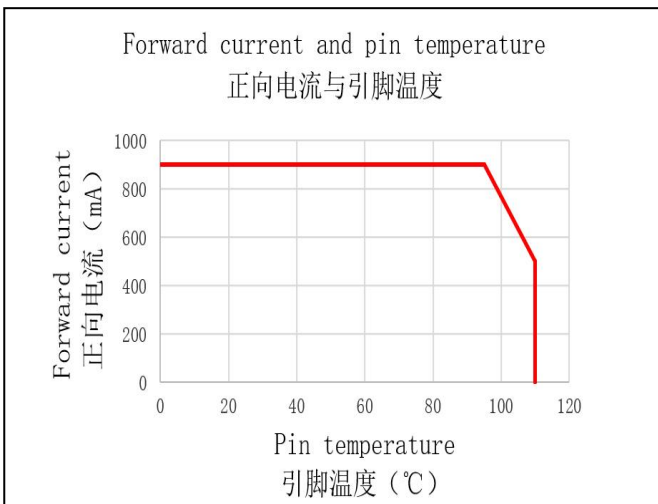
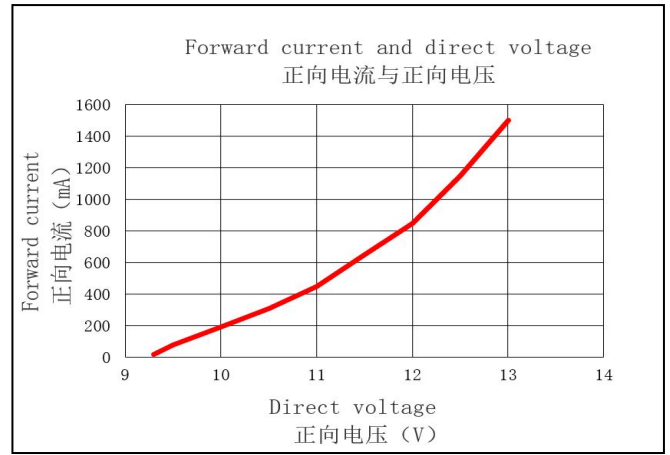
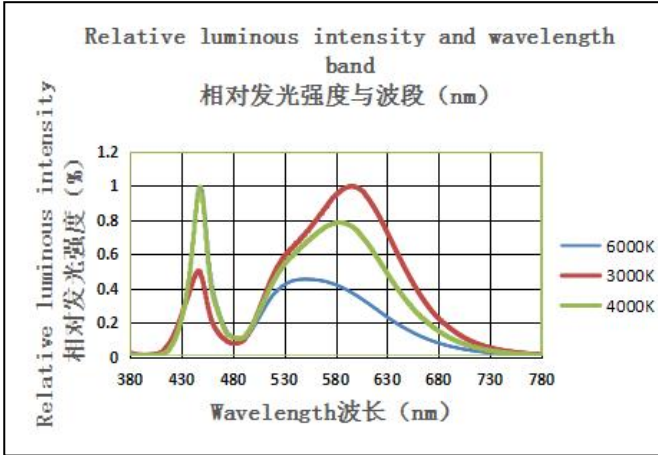

Notes:

1. Related to the temperature test based on the right current. 与温度相关测试基于额定电流。

2. All measurements were made under the standardized environment of XUYU. 所有测试都是基于旭宇光电（深圳）股份有限公司现有的标准测试平台。

◆ Packaging Specifications 包装规格

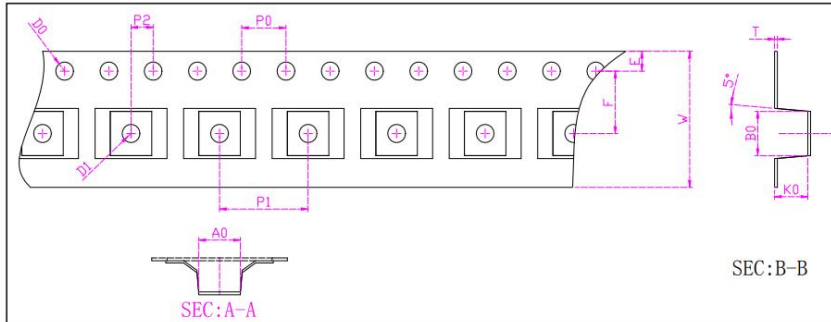

W	12.00 ±0.10	T	0.22± 0.05	D1	1.6±0 .10	单位	MM
E	1.75± 0.10	F	5.50± 0.10	D0	1.6±0 .10	材质	黑色PC+PS
P0	4.00± 0.10	P1	8.00± 0.10	P2	2.00± 0.10	品名	3535
A0	3.70± 0.10	B0	3.90± 0.10	K0	3.10± 0.10	制造商	新创源

Dimensions of Reel 卷盘规格

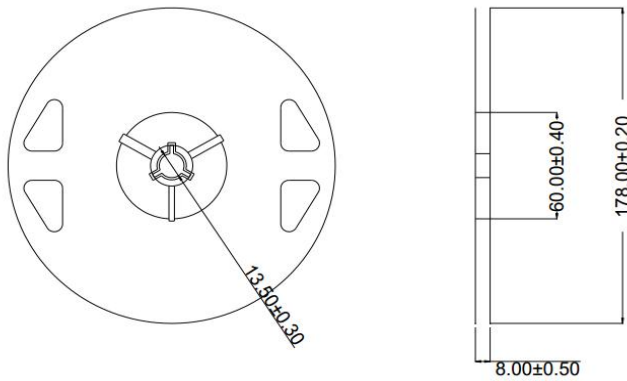

Packaging specifications 包装规格

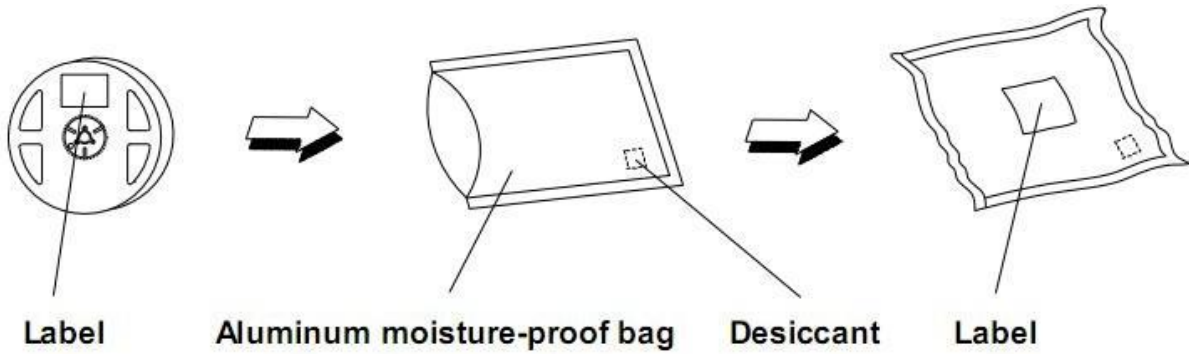

Label(标签):

Part NO: Product model 产品型号

LOT NO: Instruction number 指令单号

Spec NO: product 产品规格

Date: Date 日期

Bin No.: Class-Bin No.-Wavelength code 班别-Bin 号-波段代码

Q'ty: Quantity 数量

IF (mA) : Forward current 正向电流

VF (V) : Forward voltage 正向电压

Φ (mW) : Radiant flux 光通量

λ_p (nm): Peak Wavelength 峰值波长



◆ SMT Reflow Soldering Instructions SMT 回流焊说明

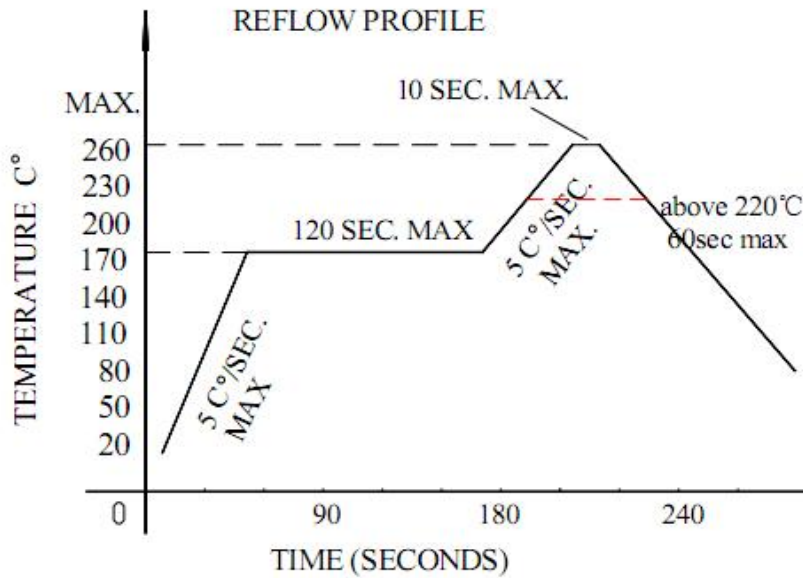

1. Reflow soldering should not be done more than two times
回流焊不可以做两次以上
2. When soldering, do not put stress on the LEDs during heating
当焊接时，材料受热，不可以用力按压胶体表面

◆ CARTIONS 注意事项

1. Before opening packaging, avoid moisture entry into LED. SMD series LED is suggested to be stored in a drying cabinet with built-in desiccant. The storage environment is 5-30 centigrade, no more than 50% humidity. If storage time is over 3 months, LED needs to be re dehumidifying (65 degrees centigrade for more than /24 hours).

1.开包装前避免湿气进入 LED 内部，建议 SMD 系列 LED 存放在内置干燥剂的干燥柜中，储存环境为温度 5-30°C，湿度不超过 50%，若存储时间超过 3 个月，LED 需要重新除潮（65°C/24 小时以上）。

2.LED electrode and bracket are made of silver plated copper alloy. The silver layer on the surface is easy to be affected by corrosive gases. Please avoid contacting with corrosive environment to cause LED discoloration, so as to avoid the poor weldability of LED and

influence the photoelectric performance. Avoid sudden changes in temperature and humidity of the environment, especially under high humidity environment, easy to produce water vapor condensation.

2. LED 电极和支架是由镀银的铜合金组成，外表银层易受到腐蚀性气体影响，请避免接触腐蚀的环境造成 LED 变色，以免产生 LED 的焊接性变差或者影响光电性能。请避免环境温湿度的骤变，尤其是高湿环境下易产生水汽凝结。

3.The encapsulated material of the LEDs is silicone. Therefore the LEDs have a soft surface on the top of package. The pressure to the top surface will be influence to the reliability of the LEDs. Precautions should be taken to avoid the strong pressure on the encapsulated part. So when use the picking up nozzle, the pressure on the silicone resin should be proper.

3、LED 封装为硅胶，故 LED 胶体表面较软，用力按压胶体表面会影响 LED 可靠性。应避免使用较大压力按压胶体表面，在使用吸嘴时，作用于胶体表面的力应适宜。

4.Handle the component along the side surface by using forceps or appropriate tools; do not directly touch or Handle the silicone lens surface, it may damage the internal circuitry.

4、采用合适的工具从侧面夹取材料，不要用手或尖锐金属按压胶体表面，否则可能导致内部电路损坏。

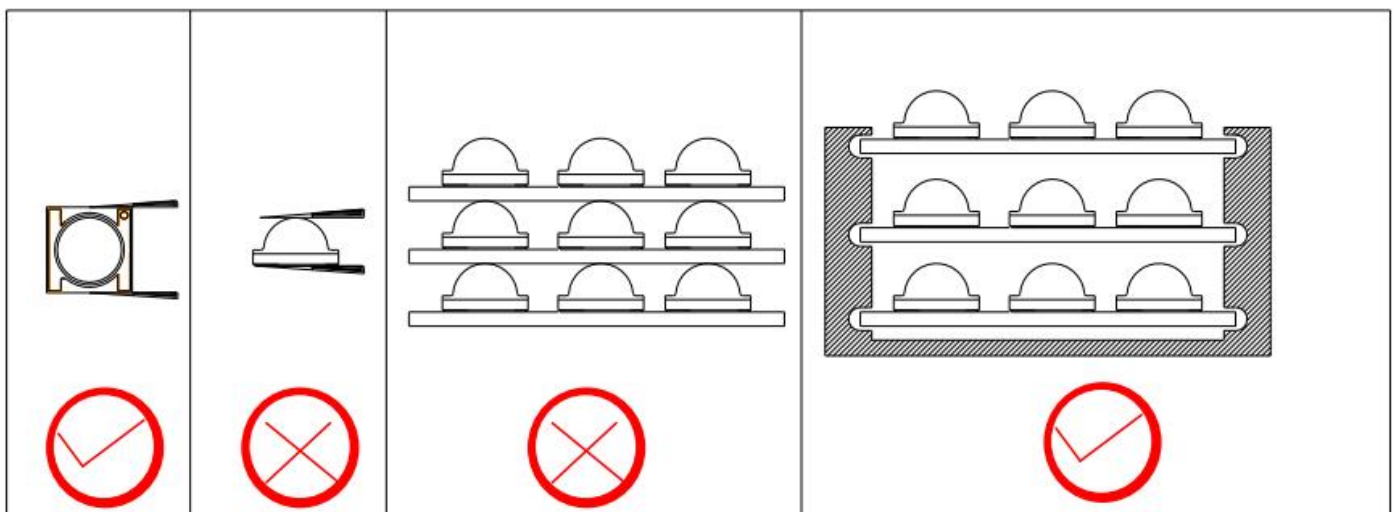

5.Electrostatic protection. LED is a chip sensitive electronic component. Various measures should be taken to avoid static electricity, such as wearing an electrostatic bracelet or anti-static gloves during use. All devices, equipment and instruments should be well grounded.

5、静电防护。LED 是晶片敏感电子元器件，应采取各种措施避免静电，诸如在使用过程中戴静

电手环或防静电手套。所有的装置、设备仪器应良好接地。