



6868UVC 产品规格书

XY-6868UVCAU5WX1FL-QU

<p>◆Features特性:</p> <ul style="list-style-type: none">* 深紫外LED* 陶瓷氮化铝平面石英透镜封装* 尺寸 (mm) 6.78*6.78*1.51* 高可靠性	<p>产品应用:</p> <ul style="list-style-type: none">* 消毒* 空气消杀* 水消杀* 分析检测
---	--

	CAUTION
	<ul style="list-style-type: none">· LEDs emit very strong UV radiation.· Don't look directly into the LED light. UV radiation can harm your eyes.· To prevent even inadequate exposure, wear protective eyewear.· If LEDs are embedded in devices, please indicate warning labels against the UV light LED used.· Keep out of reach of children.· Specification and dimension are subject to change for improvement without notice.

XUYU OPTOELECTRONICS (SHENZHEN)

Address: A1 Building, Sunshine Industrial Park, Hezhou, Xixiang, Bao'an District
Shenzhen City, Guangdong Province, China.

地址: 广东省深圳市宝安区西乡鹤洲阳光工业区A1栋

Tel: 0755- 81453318-3328/3338

Fax: 0755-81453199

<http://www.xuyuled.com>

◆ 产品外观尺寸

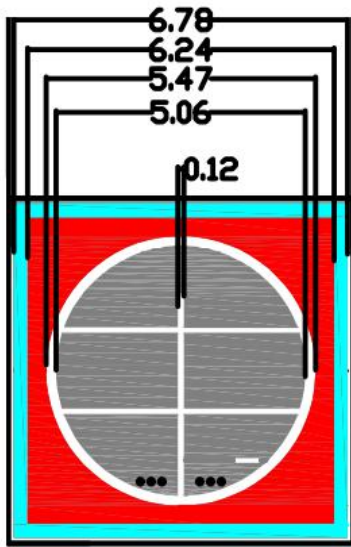

正面叠加图

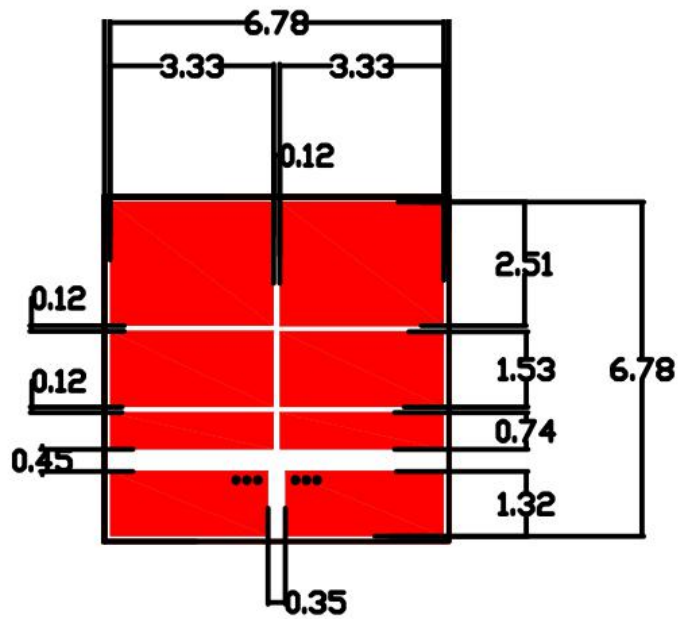

背面叠加图

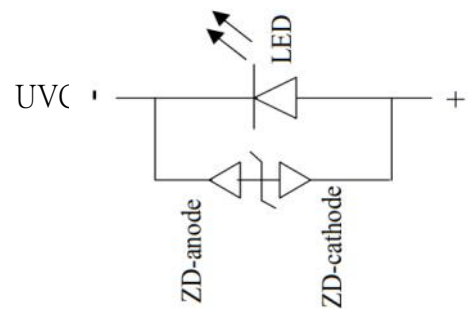
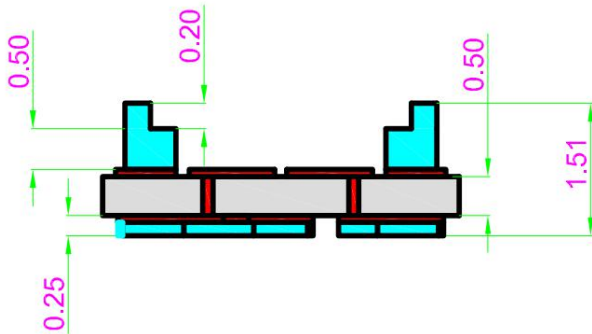

Notes:

1. All dimensions are in mm 所有尺寸单位为毫米。
2. Tolerance is $\pm 0.2\text{mm}$ unless otherwise noted. 非特殊标注，公差为 ± 0.2 毫米。

◆ **Absolute Maximum Ratings** **最大额定值** (Ta=25°C)

Parameter (参数)	Symbol (符号)	Value (值)	Unit (单位)
Power Dissipation 额定功率	P	5	W
Forward Current 正向电流	I _F	600	mA
Maximum Current 最大电流	I _F	700	mA
Thermal Resistance 热阻	R _{th}	3	°C/W
Operating Temperature Range 工作温度范围	T _{opr}	-40 to +60	°C
Storage Temperature Range 储存温度范围	T _{stg}	-40 to +60	°C
Soldering Temperature 回流温度	T _{sld}	260°C for 5 seconds	

◆ **Initial Electrical/Optical Characteristics** **初始光电特性** (Ta=25°C)

Parameter 参数	Symbol 符号	Min 最小值	Typ 典型值	Max 最大值	Unit 单位
Peak Wavelength 峰值波长	λ _p	265	---	285	nm
Radiant Flux 辐射通量 (I _F =600mA)	Φ _e	80	---	120	mW
Forward Voltage 正向电压	V _F	5	---	8	V
Spectra half-width 光谱半宽	Δλ	---	12	---	nm
Junction Temperature 结温	T _J	---	60	80	°C

Notes:

1. Forward voltage measurement allowance is ±0.2 V. 正向电压测量误差±0.2V。
2. Radiant flux measurement allowance is ±10%. 辐射通量测量误差为±10%。
3. Irradiance tested at a distance 10mm from Al reflector. 在距离铝反射器 10mm 处测试辐射照度。
4. Wavelength measurement allowance is ±3nm. 波长测量误差±3nm。

◆ Typical Characteristic Curves 典型特性曲线

Forward Current VS Forward Voltage 伏安特性曲线

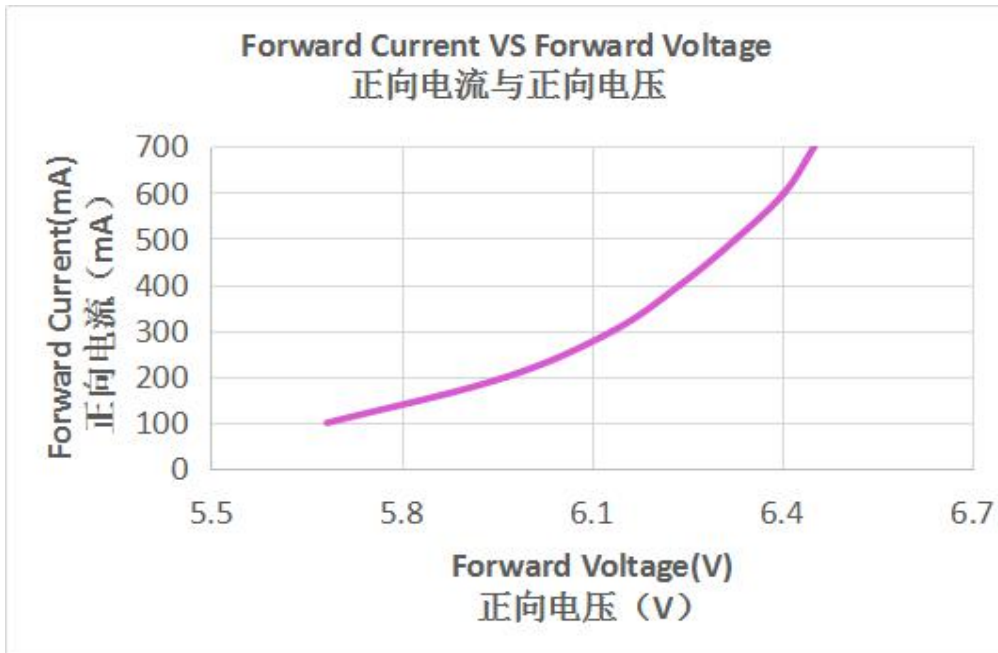

Radiant Flux VS Forward Current 辐射通量与正向电流

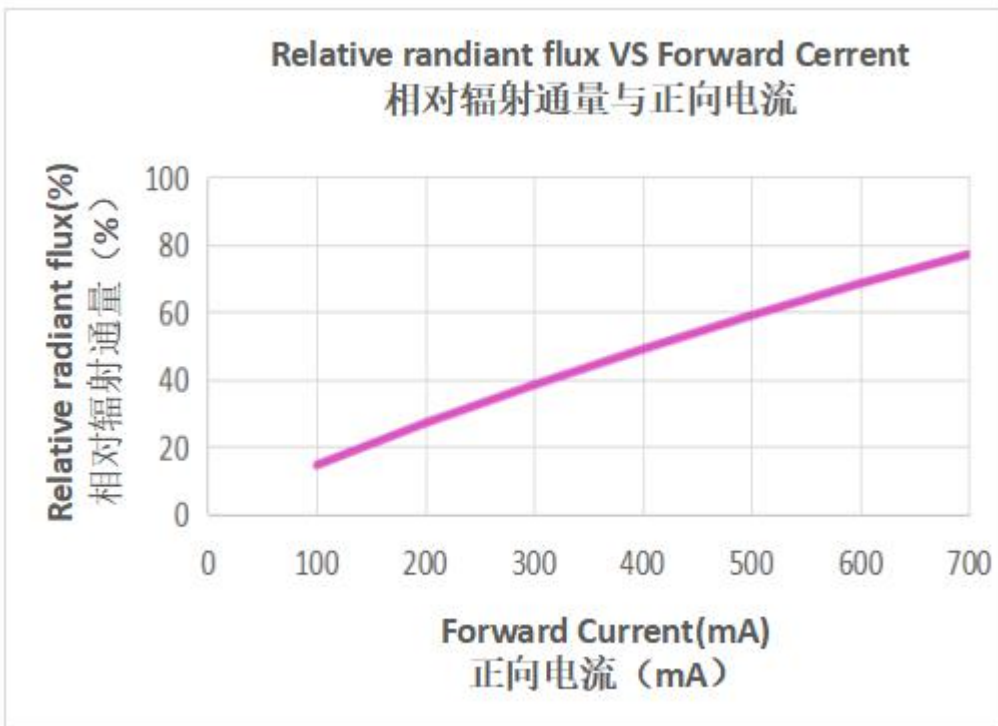

Spectral Power distribution 光谱能量分布图

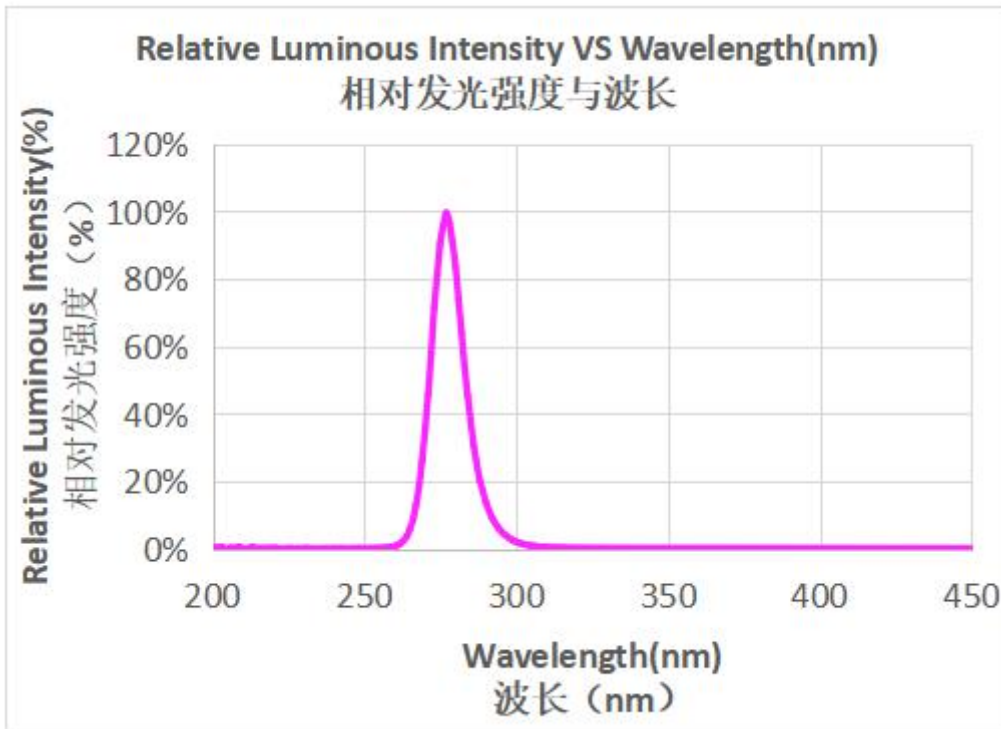

Typical Radiation Angle 典型辐射角度

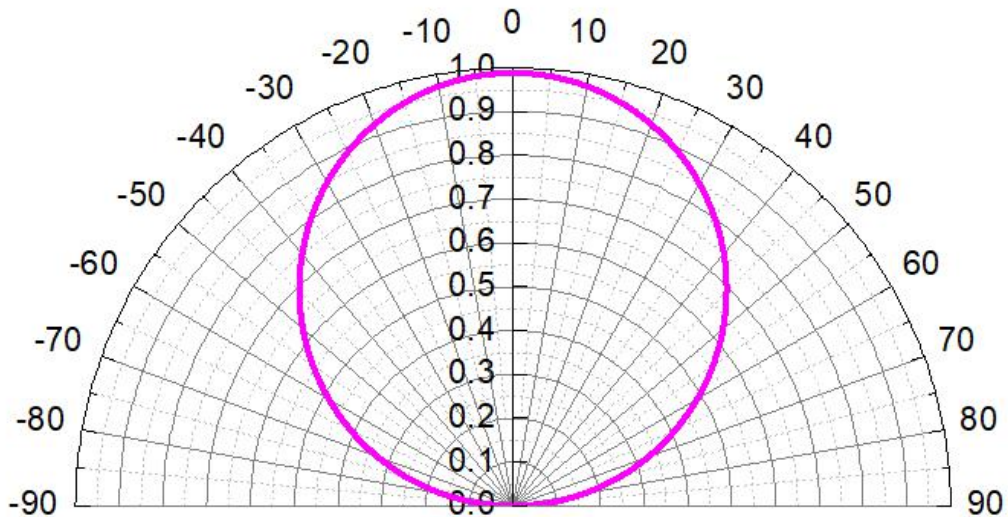

Relative Radiant Flux VS Ambient Temperature 相对辐射通量与环境温度

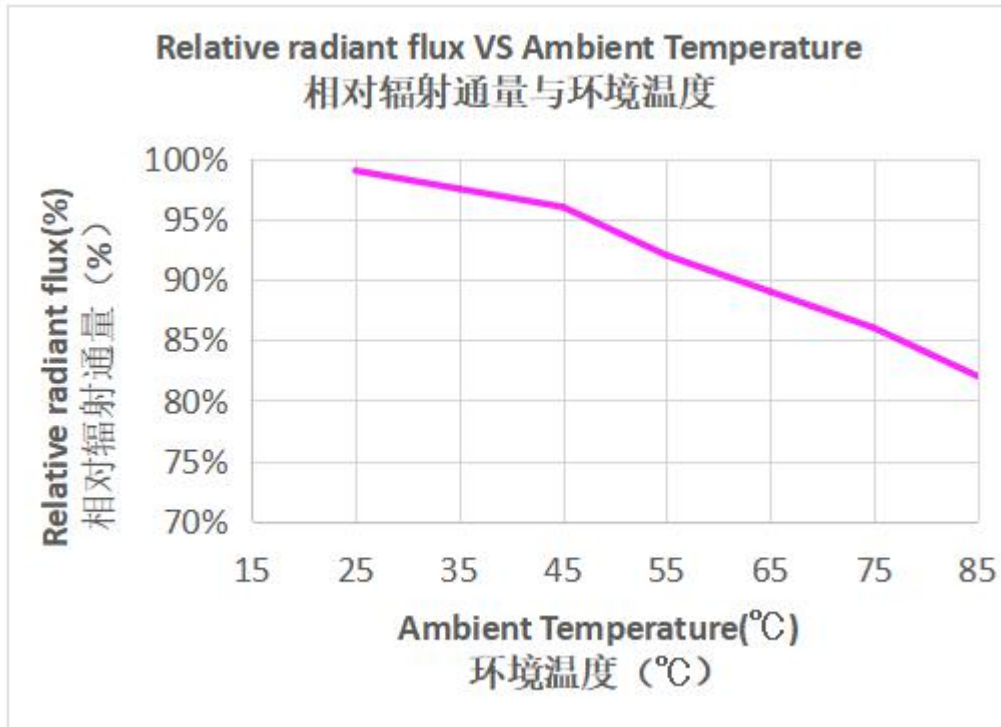

Peak Wavelength VS Ambient temperature 峰值波长与环境温度

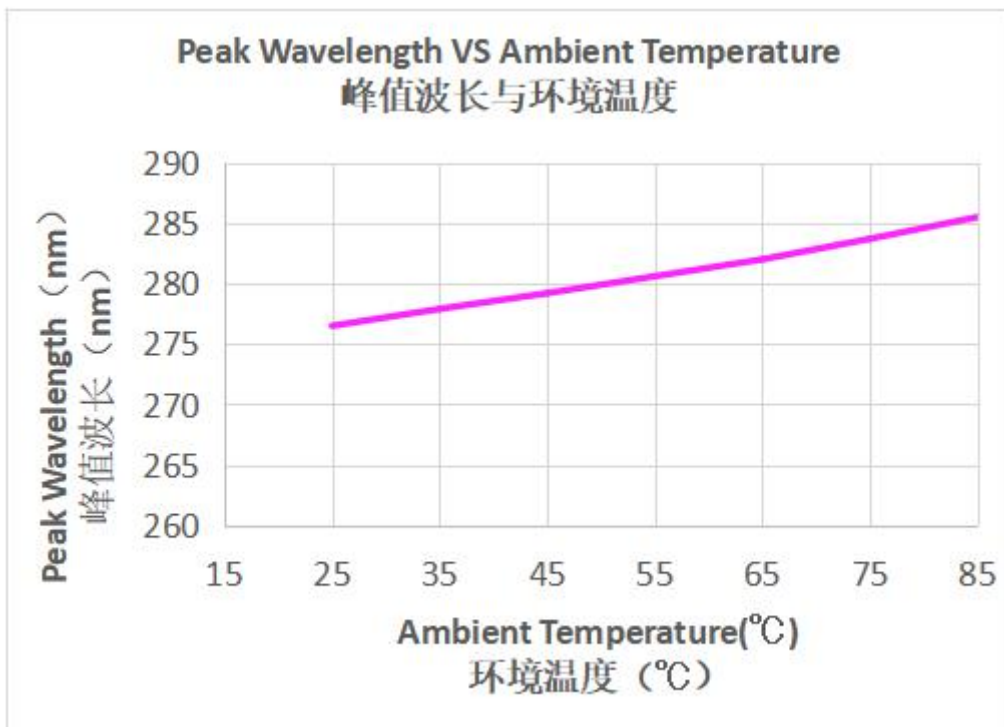

Label(标签):

Part NO: Product model 产品型号

LOT NO: Instruction number 指令单号

Spec NO: product 产品规格

Date: Date 日期

Bin No.: Class-Bin No.-Wavelength code 班别-Bin 号-波段代码

Q' ty: Quantity 数量

IF (mA) : Forward current 正向电流

VF (V) : Forward voltage 正向电压

Φ (mW) : Radiant flux 辐射通量

λ_p (nm): Peak Wavelength 峰值波长

旭宇光电（深圳）股份有限公司 XUYU OPTOELECTRONICS (SHENZHEN) CO.,LTD.	
Part No. :	Lot No. :
Spec No. :	Date. :
Bin No. :	IF(mA) :
	Qty. :
	Min Max
Vf(V)	
Φ_e (mW)	
λ_p (nm)	



◆ Shipping package style 运输包装方式

Tapping dimension package specification 尺寸包装规范

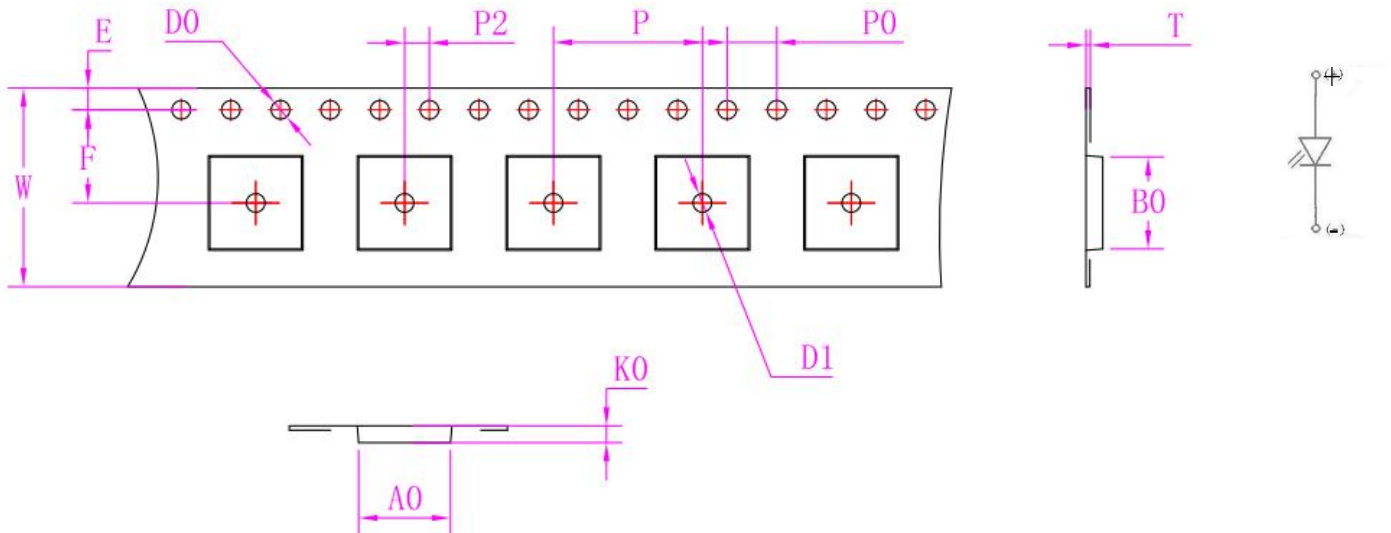

GENERAL TOLERANCE		Designed	Checked	Approved
X. ± 0.20	X. $\pm 2^\circ$	LM ZENG	BL HE	GAO Q
. X ± 0.15	. X $\pm 1^\circ$			
. XX ± 0.10	. XX $\pm 0.5^\circ$	18. 07. 09	18. 07. 09	18. 07. 09

Reel packaging 卷盘包装

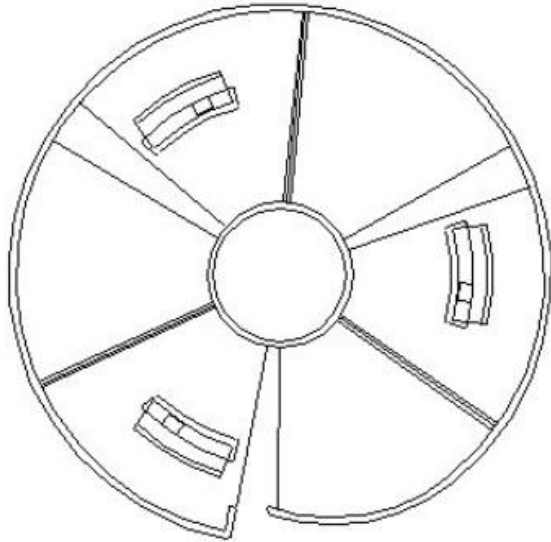

Available Reel Sizes(mm)		
Top Width	$B \pm 0.5\text{mm}$	$W + 1\text{mm}$
12mm	$\varnothing 100\text{mm}$	12.5mm

◆ SMT Reflow Soldering Instructions SMT 回流焊说明

Soldering recommend soldering conditions 焊接推荐条件

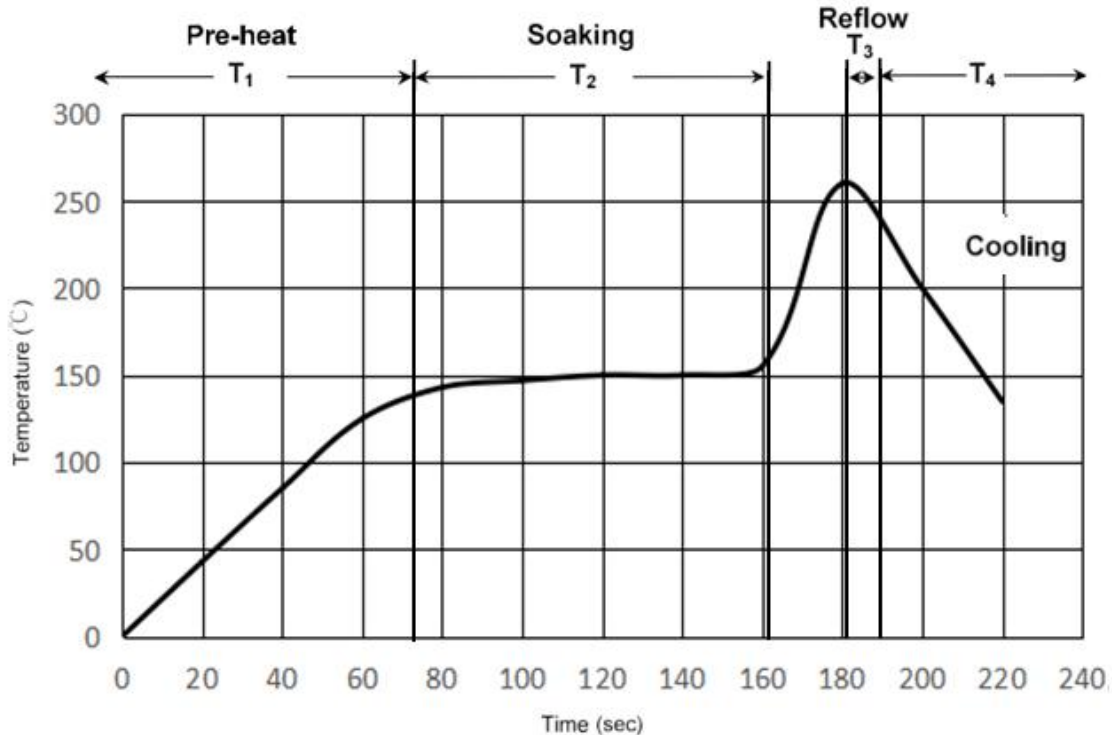

T1	Ramp up rate 上升速率	1.0-3.0 °C/ sec
	Pre-heat time 预热时间	50-80 sec
T2	Soaking temperature 焊接温度	155-185°C
	Dwell time during soaking 焊接停留时间	60-120 sec
T3	Reflow temperature 回流温度	250~260°C
	Reflow time 回流时间	Max 5 sec
	Ramp up rate during reflow 回流过程中的上升速率	1.2-2.3 °C/ sec
T4	Cooling rate 冷却速率	1.0-6.0 °C/ sec

Note: Suggest using Sn₉₆Ag₃Cu_{0.5} lead free solder 注: 建议使用 Sn₉₆Ag₃Cu_{0.5} 无铅焊料
Use alcohol cleaning solvents such as isopropyl alcohol to clean the LED if necessary 如有必要, 使用酒精清洁 LED

◆ Cautions on Use 使用注意事项

The product must be handled with care, it is strictly forbidden to fall, and it is strictly forbidden to touch the product, especially the light-emitting surface of the lamp.

产品须轻拿轻放，严禁跌落、严禁锐器接触产品特别是灯珠出光面。

Do not use a power supply that does not meet the requirements for driving.

请勿使用不符合要求的电源进行驱动。

The product should not be lit for a long time in a high temperature and closed environment in an environment within the rated temperature range.

产品应用于额定温度范围内的环境中，不得在高温密闭环境中长时间点亮。

Do not expose the LED directly to high humidity. It should be waterproof and moisture-proof.

请勿将 LED 直接裸露在高湿环境下，应做好防水防湿隔离处理。

The light-transmissive window on the light-emitting side of the product should be made of high-purity quartz glass plate, which can effectively pass 270~285 nm ultraviolet light.

产品出光侧的透光窗口应使用高纯石英玻璃板，可有效透过 270~285 nm 紫外线。

Reflow soldering should not be done more than two times. Please refer to the instruction manual for reflow temperature

回流焊不能超过 2 次，回流焊温度请参考使用说明书。

This product produces deep ultraviolet rays when energized. This kind of ultraviolet light can cause damage to human skin and eyes, and should be avoided without direct protection. The human body is directly exposed to deep ultraviolet rays.

本产品通电后会产生深紫外线。这种紫外线对人的皮肤及眼睛会造成伤害，应避免未加防护措施人体直接暴露在深紫外线中。

It is strictly forbidden to look directly at the deep ultraviolet light emitted by this product.

任何时候严禁裸眼直视本产品发射出的深紫外线。

The machine operator must bring an electrostatic ring.

所有接触产品人员务必戴静电手环。

The machine must be grounded.

务必操作机台接地线

